

VULKAN



SMART STREET

The VULKAN series is a new Smart Street, Pole Top with Symmetric direct Architectural Garden, Park or Street Lighting Series in Power LED Version providing precision optical system which gives very low glare rating, while reducing light pollution. It can achieve the desired effect in a wide range of applications with high quality optical systems and for direct lighting. VULKAN series are designed to offer functional, a wide range of lighting solution and dramatic highlighting through the design with super finishing as well highest efficiency with long service life. This product provide soft, uniform, enhancing special lighting effect that blends into the space being lit, to maximizes light beauty.

Designed to illuminate Parks, Garden, Streets, Urban Centers, Squares, Pedestrian and more.

The housing materials of the fixture of this series can be specified as main structure made of heavy duty Die cast aluminum covered by anti-corrosion resistant covering 5 years of warranty.

The VULKAN series is equipped with a uniquely designed for better protection and durability, easier installation and maintenance.



Description

350mA/500mA/750mA/1050mA

Body:	Heavy Duty Die-cast aluminium.
Optical system:	Adopt modular light distribution lens, diffuser with super white, UV Resistant and Antiglare tempered Flat glass lens diffuser.
LED	Highest quality LEDs. Maintaining a 3-Step MacAdam ellipse one bin only, creating perfect LED color consistency.
LED Life	50,000 Hrs or more based on Climate /Ambient Temperature
Gear plate:	Galvanized steel plate, button design for opened device. Built in Electronics Driver (Meanwell / OSRAM / Tridonic Atco / Philips / Inventronics / Eagle, etc. Durable Silicon Rubber Gasket. 3000/4000/6000K CCT. Excellent heat dissipation. Color Rendering Index is 80+.
uminaire ontrol:	Quick on/off connector when be open.
Finishing:	Surface anti-ageing electrostatic spray processing, super resistance to corrosion and chemical protection.
Assembling height:	4-6 m.
Fixing:	Top or side fitting Ø60mm, angle can be adjustable.
Operating Temperature	-30°C to 50°

PHILIPS
LUMILEDS



Due to continuous improvements, specifications may change without prior notice.



VULKAN

SMART STREET

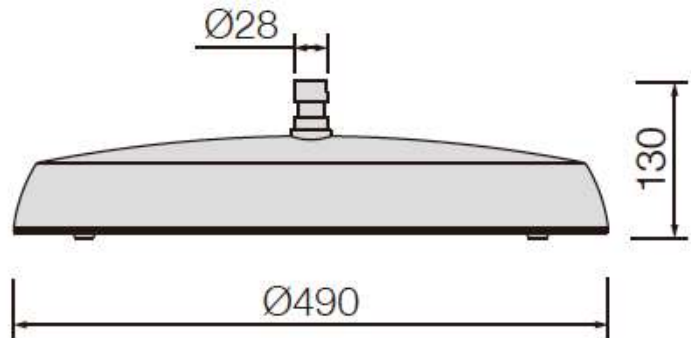
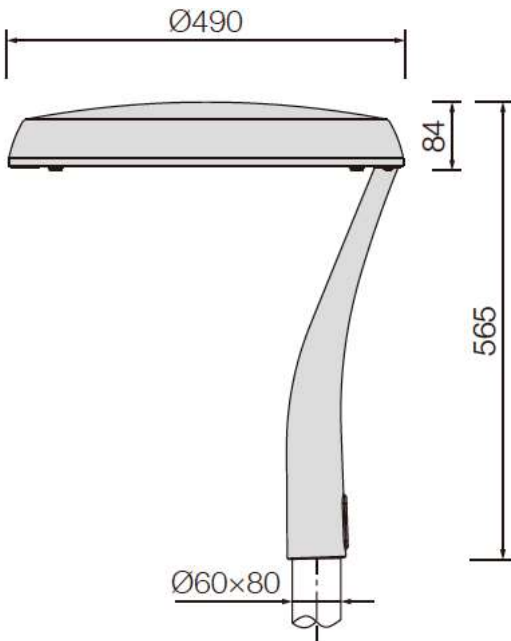
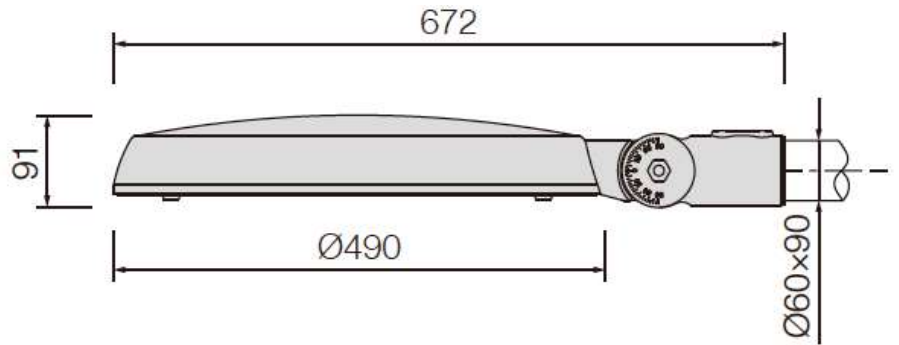
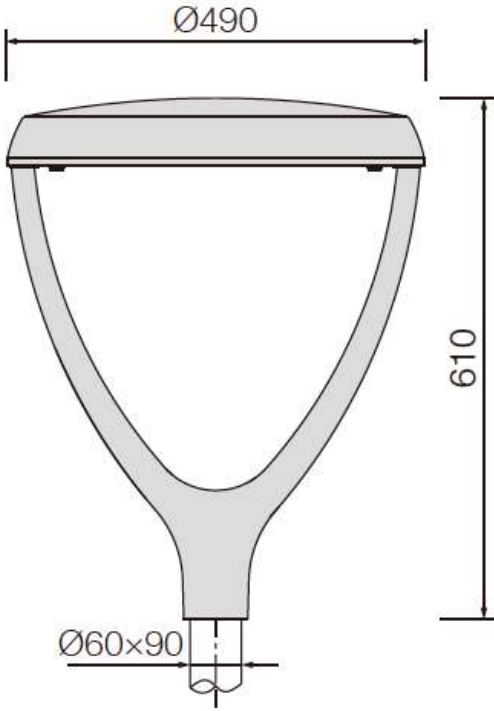

Due to continuous improvements, specifications may change without prior notice.



VULKAN

SMART STREET

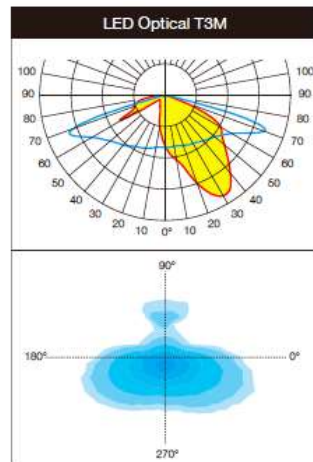
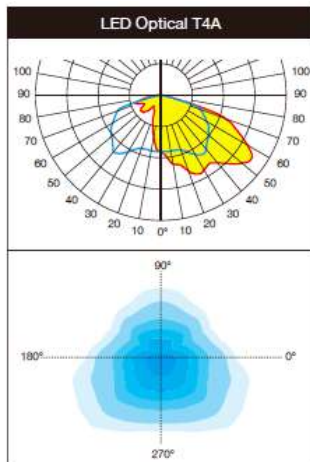
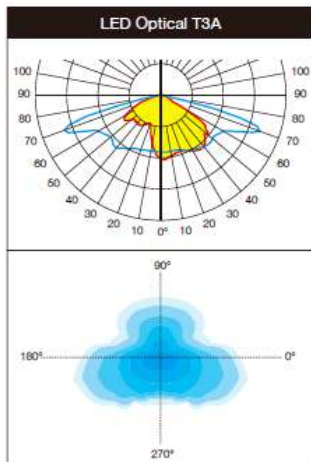
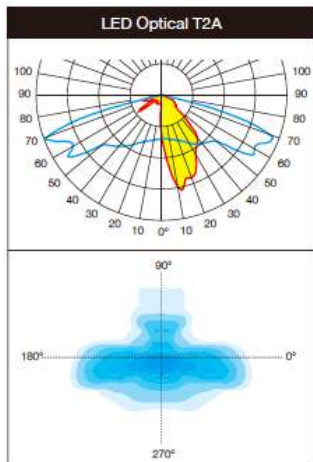
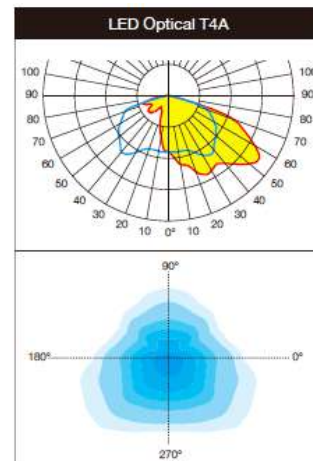
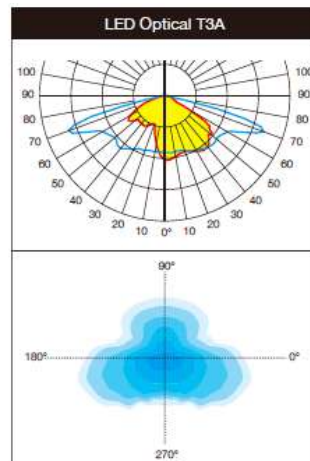
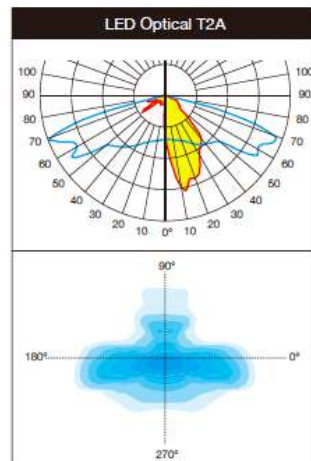
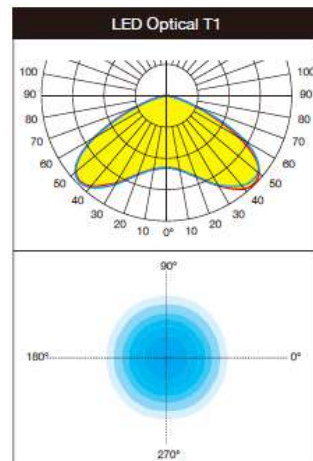
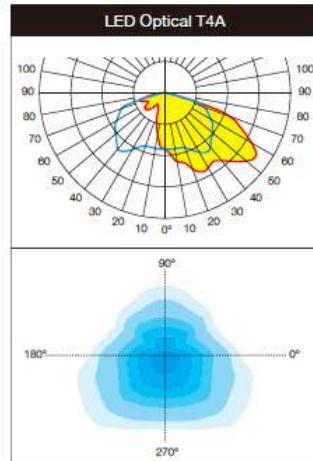
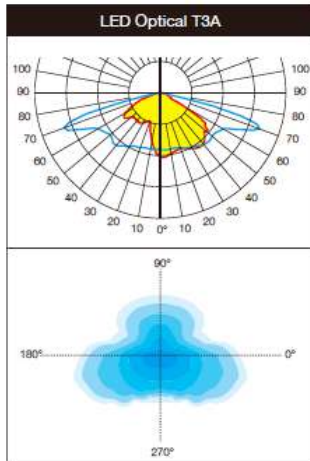
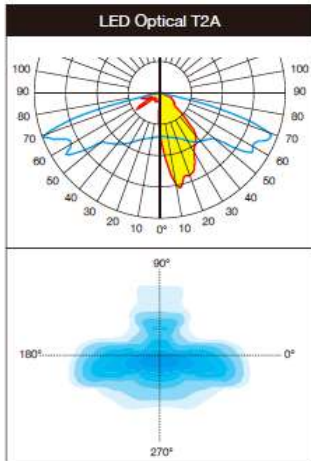
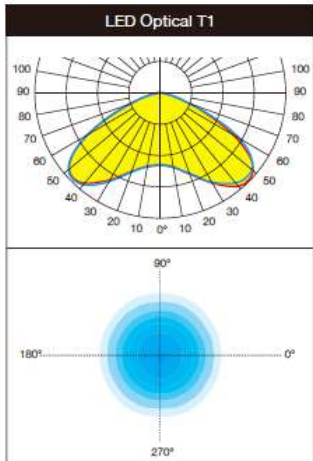

VULKAN



SMART STREET

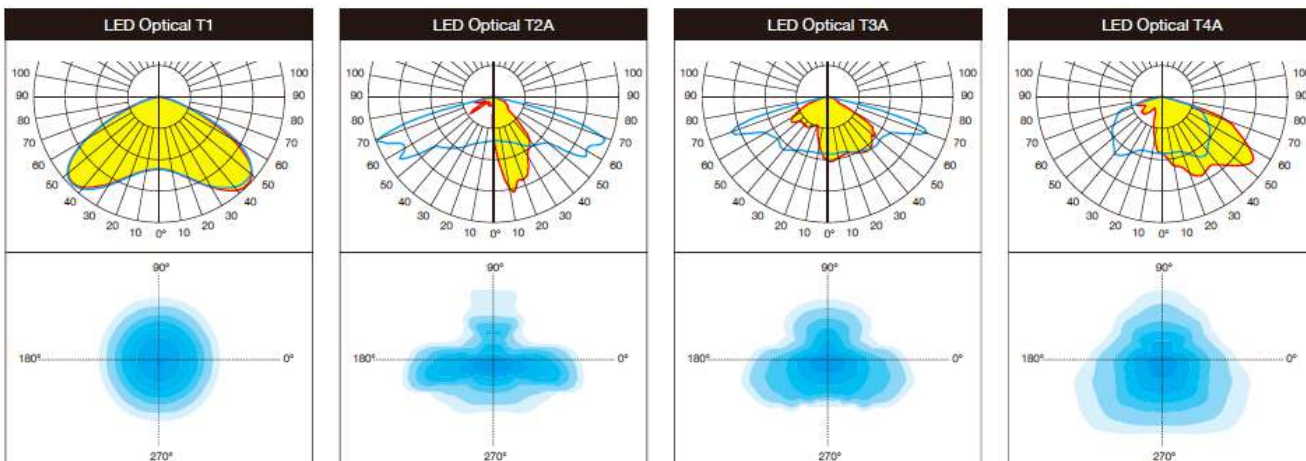

Due to continuous improvements, specifications may change without prior notice.

Technology Data

Code	Lamp	Watt	LED Pcs	lumens	LED
VULKAN	LED	30W	16 / 56	75-98 Lumens @ Watt	PHILIPS LUMILEDS CREE
		40W	24 / 56	3000K 4000K 5000K 6000K	
		60W	24 / 84		
		80W	36 / 96		



VULKAN









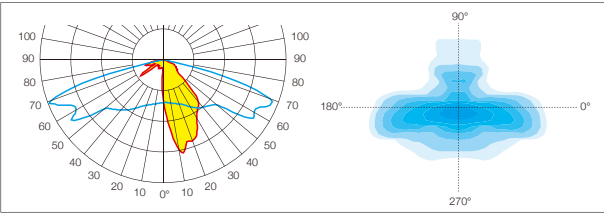

SMART STREET

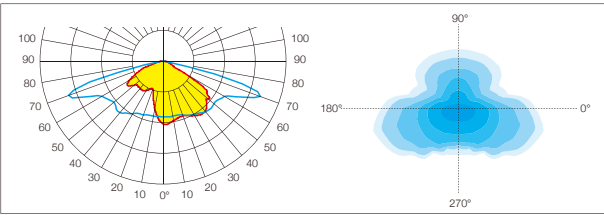

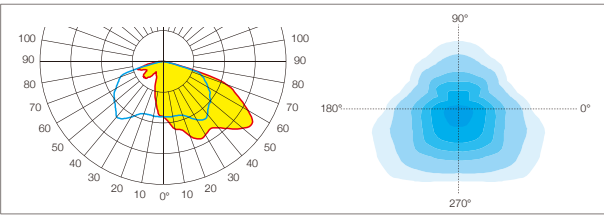

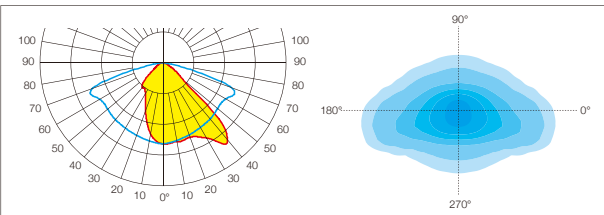

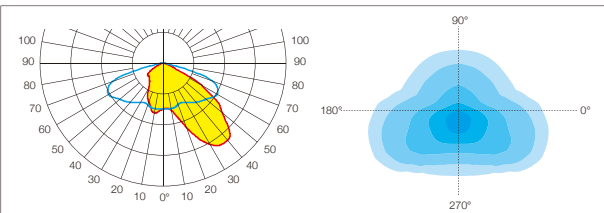

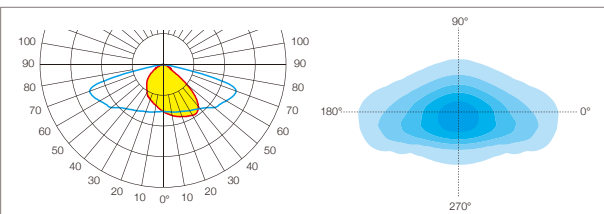

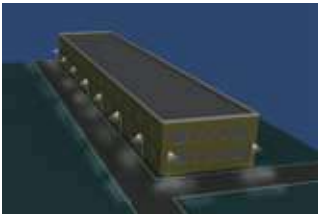
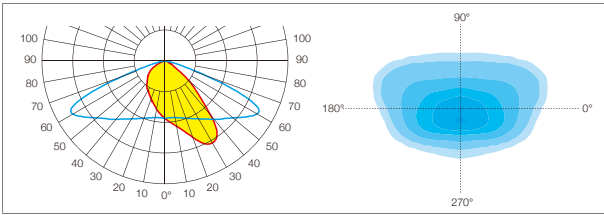

Due to continuous improvements, specifications may change without prior notice.

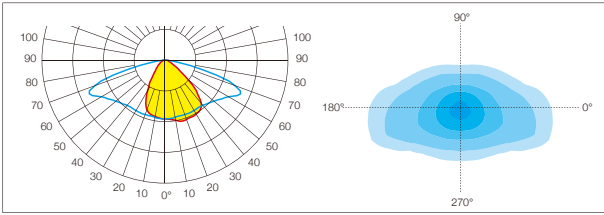

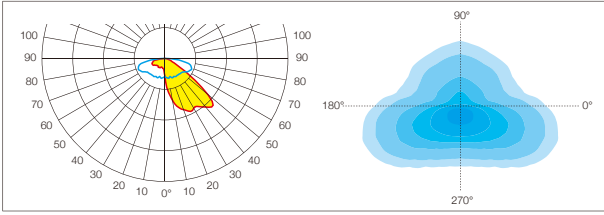
Lens Application

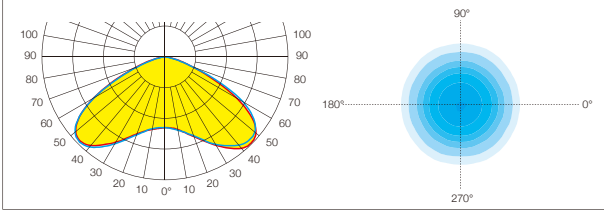
Reference	Destination	Light Distribution	Application
T2A			Asymtric light distribution for Narrow road. LED Chips: 2x2
T3A			Asymtric light distribution for Residential street. LED Chips: 2x2
T4A			Asymtric light distribution for wide area. LED Chips: 2x2
T3			Asymtric light distribution for urban road. LED Chips: 2x2
T4			Asymtric light distribution for motorway road. LED Chips: 2x2
T5			Asymtric light distribution for urban road. LED Chips: 1x15

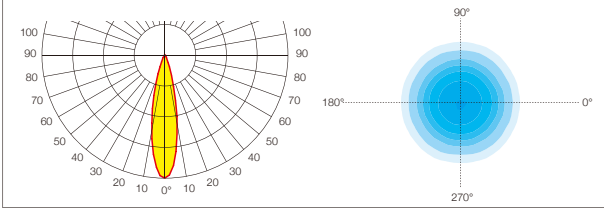

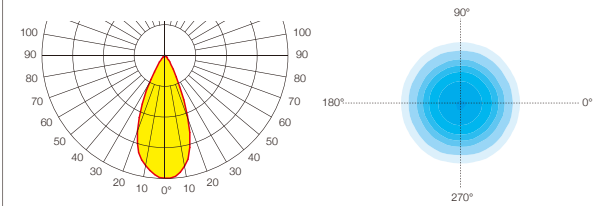
Reference	Destination	Light Distribution	Application
T12			Asymtric light distribution for Residential street. LED Chips: 1x1
T13			Asymtric light distribution for urban road. LED Chips: 1x1
T14			Asymtric light distribution for middle area. LED Chips: 1x1
T1			Symtric light distribution for square, park, highbay lighting. LED Chips: 2x2
T25			Symtric light distribution for narrow angle flood, highbay lighting. LED Chips: 2x2
T60			Symtric light distribution for middle angle flood, highbay lighting. LED Chips: 2x2

